

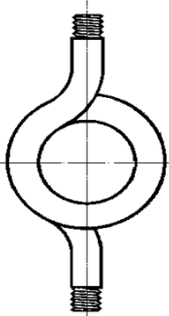

ACCESSORIES

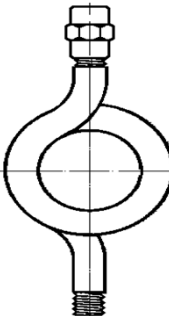
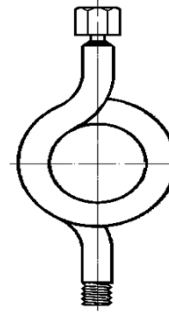
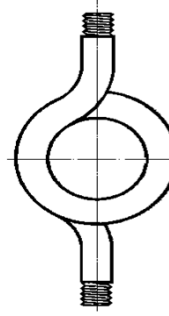
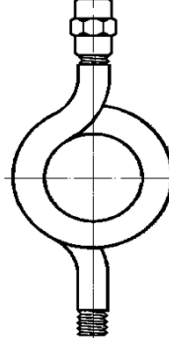
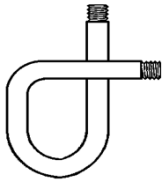
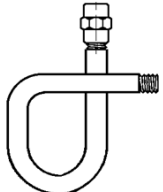
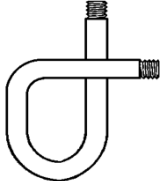
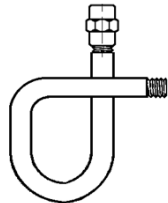
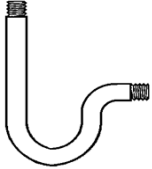
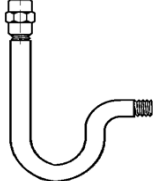
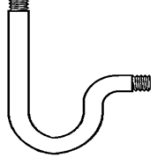
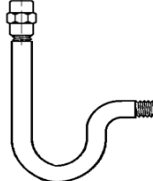

ARTICLE	DESCRIPTION	REF.	CODE	INT	OUT	€
	SIPHON TUBE for pressure gauges Carbon steel Threaded BSP male-male	527				
		PN64	02640000	1/4"	1/4"	
		PN64	03640000	3/8"	3/8"	
		PN64	04640000	1/2"	1/2"	
		PN32	02320000	1/4"	1/4"	
		PN32	04320000	1/2"	1/2"	
	SIPHON TUBE for pressure gauges SIPHON: Carbon steel Sleeve: Brass Threaded BSP male-female	527				
		PN64	02644000	1/4"	1/4"	
		PN64	03644000	3/8"	3/8"	
		PN64	04644000	1/2"	1/2"	
		PN32	02324000	1/4"	1/4"	
		PN32	04324000	1/2"	1/2"	
	SIPHON TUBE for pressure gauges SIPHON: Carbon steel Rotatory Sleeve: Brass Threaded BSP male-female	527				
		PN64	02648000	1/4"	1/4"	
		PN64	03648000	3/8"	3/8"	
		PN64	04648000	1/2"	1/2"	
	SIPHON TUBE for pressure gauges Stainless steel AISI 316 or 304 Threaded BSP male-male	527.2				
		PN64	02640020	1/4"	1/4"	
		PN64	03640020	3/8"	3/8"	
		PN64	04640020	1/2"	1/2"	
		PN40	02400020	1/4"	1/4"	
		PN40	04400020	1/2"	1/2"	
	SIPHON TUBE for pressure gauges SIPHON: Stainless steel 316/304 Sleeve: Stainless steel 304 Threaded BSP male-female	527.2				
		PN64	02644020	1/4"	1/4"	
		PN64	03644020	3/8"	3/8"	
		PN64	04644020	1/2"	1/2"	
		PN40	02404020	1/4"	1/4"	
		PN40	04404020	1/2"	1/2"	

ARTICLE	DESCRIPTION	REF.	CODE	INT	OUT	€
	SIPHON TUBE CARBON STEEL Threaded BSP male - male PN-64	528	02000000 03000000 04000000	1/4" 3/8" 1/2"	1/4" 3/8" 1/2"	
	SIPHON TUBE CARBON STEEL With brass sleeve Threaded BSP male - female PN-64	528	02004000 03004000 04004000	1/4" 3/8" 1/2"	1/4" 3/8" 1/2"	
	SIPHON TUBE STAINLEES STEEL 316 Threaded BSP male - male PN-64	528.2	02000020 03000020 04000020	1/4" 3/8" 1/2"	1/4" 3/8" 1/2"	
	SIPHON TUBE STAINLESS STEEL 316 With St. steel 316 sleeve Threaded BSP male - female PN-64	528.2	02004020 03004020 04004020	1/4" 3/8" 1/2"	1/4" 3/8" 1/2"	
	OPEN SIPHON TUBE CARBON STEEL Threaded BSP male - male PN-64	529	02000000 03000000 04000000	1/4" 3/8" 1/2"	1/4" 3/8" 1/2"	
	OPEN SIPHON TUBE CARBON STEEL With brass sleeve Threaded BSP male - female PN-64	529	02004000 03004000 04004000	1/4" 3/8" 1/2"	1/4" 3/8" 1/2"	
	OPEN SIPHON TUBE STAINLESS STEEL 316 Threaded BSP male - male PN-64	529.2	02000020 03000020 04000020	1/4" 3/8" 1/2"	1/4" 3/8" 1/2"	
	OPEN SIPHON TUBE STAINLESS STEEL 316 With St. steel 316 sleeve Threaded BSP male - female PN-64	529.2	02004020 03004020 04004020	1/4" 3/8" 1/2"	1/4" 3/8" 1/2"	

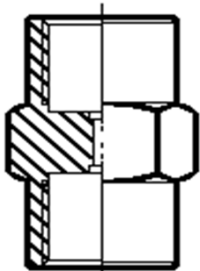
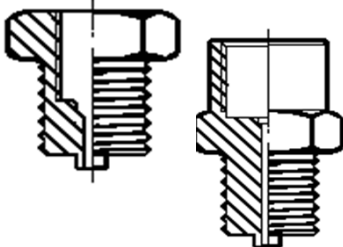
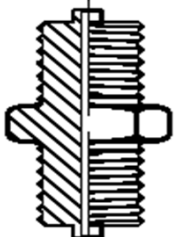
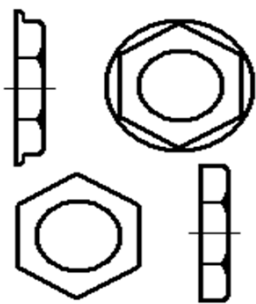
ARTICLE	DESCRIPTION	REF.	CODE	SIZE	SIZE	€			
	SLEEVE GAUGE <u>BRASS</u> FEMALE - FEMALE PN-64 Threaded BSP	531	02020000	1/4"H	1/4"H				
			02030000	1/4"H	3/8"H				
			02040000	1/4"H	1/2"H				
			03030000	3/8"H	3/8"H				
			03040000	3/8"H	1/2"H				
			04040000	1/2"H	1/2"H				
	SLEEVE GAUGE <u>Stainless steel AISI 316</u> FEMALE - FEMALE PN-64 Threaded BSP	531.2	02020020	1/4"H	1/4"H				
			03030020	3/8"H	3/8"H				
			04040020	1/2"H	1/2"H				
			06060020	3/4"H	3/4"H				
	SLEEVE GAUGE <u>BRASS</u> MALE - FEMALE PN-64 Threaded BSP Otras medidas CONSULTAR	532	01020000	1/8"M	1/4"H				
			02020000	1/4"M	1/4"H				
			02030000	1/4"M	3/8"H				
			02040000	1/4"M	1/2"H				
			03030000	3/8"M	3/8"H				
			03040000	3/8"M	1/2"H				
			04020000	1/2"M	1/4"H				
			04040000	1/2"M	1/2"H				
				SLEEVE GAUGE <u>BRASS</u> MALE - MALE PN-64 Threaded BSP	533	01010000	1/8"M	1/8"M	
						02020000	1/4"M	1/4"M	
03030000	3/8"M	3/8"M							
04040000	1/2"M	1/2"M							
	NUT <u>BRASS</u> Threaded BSP	539	01000000	1/8"					
			02000000	1/4"					
			03000000	3/8"					
			04000000	1/2"					
	NUT <u>Stainless steel AISI 316</u> Threaded BSP	539.2	02000020	1/4"					
			03000020	3/8"					
			04000020	1/2"					

We have all types of fitting and accessories, racord Marseille, caps, nuts, dowel hose, piers, reductions, threaded BSP, NPT,...

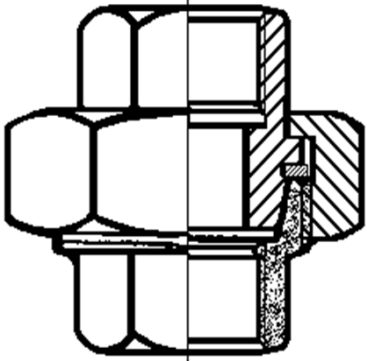
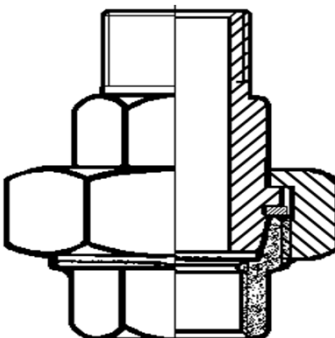
ARTICLE	DESCRIPTION	REF.	CODE	SIZE	SIZE	€	
	3 parts connections <u>Brass</u> female - female Conical seal Threaded BSP	534	03000000 04000000 06000000 10000000 12000000 14000000 20000000	3/8"H 1/2"H 3/4"H 1"H 1"¼H 1"½H 2"H	3/8"H 1/2"H 3/4"H 1"H 1"¼H 1"½H 2"H		
	3 parts connections <u>BRONZE RG-5</u> female - female Conical seal Threaded BSP	534.1	03000010 04000010 06000010 10000010 12000010 14000010 20000010	3/8"H 1/2"H 3/4"H 1"H 1"¼H 1"½H 2"H	3/8"H 1/2"H 3/4"H 1"H 1"¼H 1"½H 2"H		
	3 parts connections <u>Stainless steel Aisi-316</u> female - female Conical seal Threaded BSP	534.2	01000020 02000020 03000020 04000020 06000020 10000020 12000020 14000020 20000020 24000020 30000020 40000020	1/8"H 1/4"H 3/8"H 1/2"H 3/4"H 1"H 1"¼H 1"½H 2"H 2"½H 3"H 4"H	1/8"H 1/4"H 3/8"H 1/2"H 3/4"H 1"H 1"¼H 1"½H 2"H 2"½H 3"H 4"H		
		3 parts connections <u>Brass</u> Male - female Conical seal Threaded BSP	535	02000000 03000000 04000000 06000000 10000000 12000000 14000000 20000000	1/4"M 3/8"M 1/2"M 3/4"M 1"M 1"¼M 1"½M 2"M	1/4"H 3/8"H 1/2"H 3/4"H 1"H 1"¼H 1"½H 2"H	

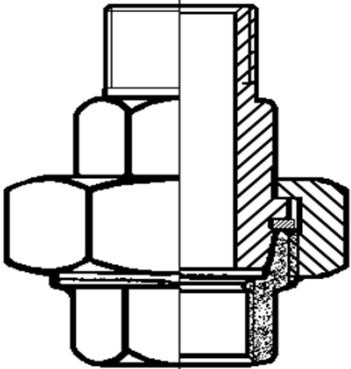
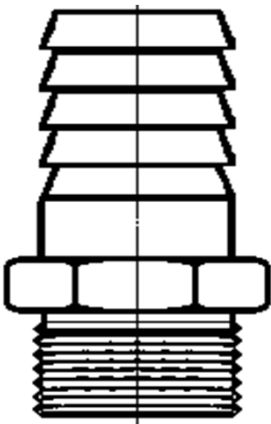
ARTICLE	DESCRIPTION	REF.	CODE	SIZE	SIZE	€
	3 parts connections <u>BRONZE RG-5</u> male - female Conical seal Threaded BSP	535.1	02000010	1/4"M	1/4"H	
			03000010	3/8"M	3/8"H	
			04000010	1/2"M	1/2"H	
			06000010	3/4"M	3/4"H	
			10000010	1"M	1"H	
			12000010	1"¼M	1"¼H	
			14000010	1"½M	1"½H	
			20000010	2"M	2"H	
	3 parts connections <u>Stainless Steel Aisi-316</u> male - female Conical seal Threaded BSP	535.2	01000020	1/8"M	1/8"H	
			02000020	1/4"M	1/4"H	
			03000020	3/8"M	3/8"H	
			04000020	1/2"M	1/2"H	
			06000020	3/4"M	3/4"H	
			10000020	1"M	1"H	
			12000020	1"¼M	1"¼H	
14000020			1"½M	1"½H		
20000020			2"M	2"H		
24000020			2"½M	2"½H		
30000020			3"M	3"H		
40000020			4"M	4"H		
	HOSE JUNCTION <u>BRASS</u> BSP Male Threaded	537	03010000	3/8"	Ø10	
			03012000	3/8"	Ø12	
			03013000	3/8"	Ø13	
			04017000	1/2"	Ø15	
			BARRA 06019000	3/4"	Ø19	
			06022000	3/4"	Ø22	
			BARRA 10025000	1"	Ø25	
			10029000	1"	Ø29	
			12034000	1"¼	Ø34	
			14045000	1"½	Ø45	
			20059000	2"	Ø59	
			HOSE JUNCTION <u>Stainless steel AISI 316</u> BSP Male Threaded	537.2	03011020	
	04013020	1/2"			Ø13	
	06016020	3/4"			Ø16	
	10025020	1"			Ø25	
	12033020	1"¼			Ø33	
	14039020	1"½			Ø39	
	20051020	2"	Ø51			

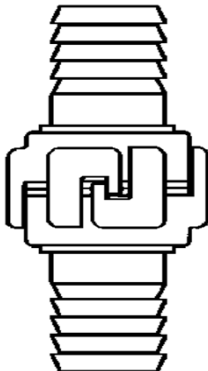
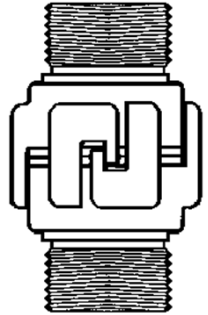
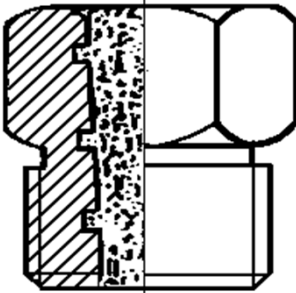
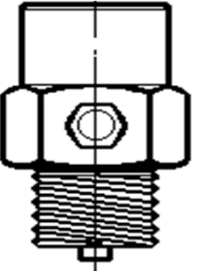
ARTICLE	DESCRIPTION	REF.	CODE	SIZE	SIZE	€
	<p>CONNECTION "BARCELONA"</p> <p><u>BRASS</u></p> <p>SPIKE x SPIKE 2 Pieces</p>	540	04000020	20mm	1/2"	
			06000025	25mm	3/4"	
			10000030	30mm	1"	
			12000035	35mm	1"¼	
			00000040	40mm		
			14000045	45mm	1"½	
			00000045	45mm	ESP.	
			00000050	50mm		
			20000060	60mm	2"	
				<p>CONNECTION "BARCELONA"</p> <p><u>BRASS</u></p> <p>MALE - MALE 2 Pieces</p>	541	
06000000	3/4"	3/4"				
10000000	1"	1"				
12000000	1"¼	1"¼				
14000000	1"½	1"½				
20000000	2"	2"				
	<p>SAFETY FUSE CAP</p> <p>Body: BRONZE RG-5 / BRASS</p> <p>Trim: LEAD / TIN</p> <p><u>Special reduced step</u> BSP male threaded</p>	544				02000000
			03000000	3/8"		
			04000000	1/2"		
			06000000	3/4"		
			10000000	1"		
			10000080	1"		
	<p>ABSORBER PRESSURE</p> <p><u>BRASS</u></p> <p>MALE - FEMALE BSP Threaded</p>	548	01000000	1/8"	1/8"	
			02000000	1/4"	1/4"	
			03000000	3/8"	3/8"	
			04000000	1/2"	1/2"	

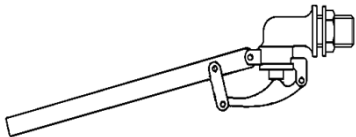
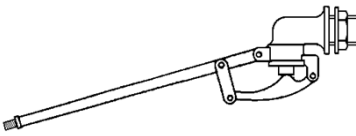
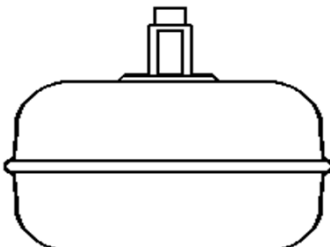
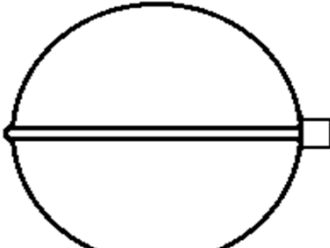
ARTICLE	DESCRIPTION	REF.	CODE	SIZE	SIZE	€
	<p>SLIDING FLOAT "TYPE MADRID"</p> <p>Brass</p> <p>Without buoy</p> <p>PN 10 BSP Male threaded</p>	583	03000000	3/8"		
			04000000	1/2"		
			06000000	3/4"		
			10000000	1"		
			12000000	1 1/4"		
			14000000	1 1/2"		
			20000000	2"		
			24000000	2 1/2"		
			30000000	3"		
	<p>THREADED FLOAT</p> <p>Brass</p> <p>Without buoy</p> <p>PN 10 BSP Male threaded</p>	584	03000000	3/8"	R 3/16	
			04000000	1/2"	R 6/100	
			06000000	3/4"	R 7/100	
			10000000	1"	R 8/100	
			12000000	1 1/4"	R 9/100	
			14000000	1 1/2"	R 9/100	
			20000000	2"	R 9/100	
	<p>FLAT SLIDING FLOAT "TYPE MADRID"</p> <p>COPPER</p>	585	03000000	3/8"	Ø120	
			04000000	1/2"	Ø120	
			06000000	3/4"	Ø150	
			10000000	1"	Ø170	
			12000000	1 1/4"	Ø200	
			14000000	1 1/2"	Ø230	
			20000000	2"	Ø250	
			24000000	2 1/2"	Ø280	
			30000000	3"	Ø300	
	<p>THREADED BALL BUOY</p> <p>BRASS * COPPER</p>	586	03000000	3/8"	Ø90	
			04000000	1/2"	Ø110	
			06000000	3/4"	Ø130	
			10000000	1"	Ø150	
			* 12000000	1 1/4"	Ø180	
			* 14000000	1 1/2"	Ø200	
			* 20000000	2"	Ø230	

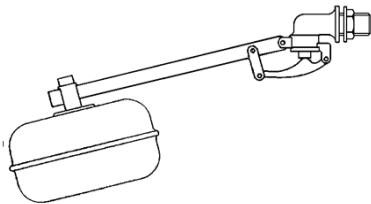
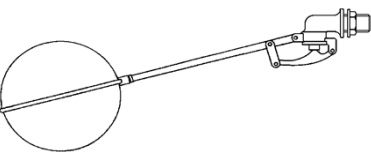
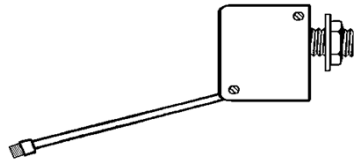
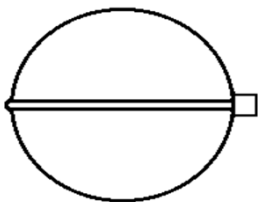
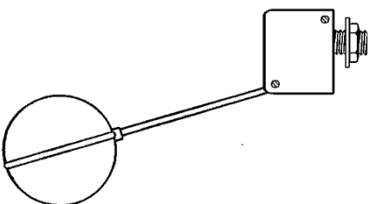
ARTICLE	DESCRIPTION	REF.	CODE	SIZE	SIZE	€
	SLINDING FLOAT+BUOY SET TYPE "MADRID" PN-10 BRASS	587	03000000	3/8"	Ø120	
			04000000	1/2"	Ø120	
			06000000	3/4"	Ø150	
			10000000	1"	Ø170	
			12000000	1"¼"	Ø200	
			14000000	1"½"	Ø230	
			20000000	2"	Ø250	
			24000000	2"½"	Ø280	
			30000000	3"	Ø300	
	THREADED FLOAT+BUOY SET SPHERICAL PN-10 BRASS	588	03000000	3/8"	Ø90	
			04000000	1/2"	Ø110	
			06000000	3/4"	Ø130	
			10000000	1"	Ø150	
			12000000	1"¼"	Ø180	
			14000000	1"½"	Ø200	
			20000000	2"	Ø230	
	THREADED FLOAT Without bouy PN-16 Stainless steel Aisi-316 AISI 304 please, request	589	03000000	3/8"	M-6	
			04000000	1/2"	M-6	
			06000000	3/4"	M-8	
			10000000	1"	M-8	
			12000000	1"¼"	M-8	
			14000000	1"½"	M-12	
			20000000	2"	M-12	
	SPHERICAL BOUY BSP threaded without float Stainless steel Aisi-316	590	03000000	3/8"	Ø90	
			04000000	1/2"	Ø110	
			06000000	3/4"	Ø160	
			10000000	1"	Ø160	
			12000000	1"¼"	Ø160	
			14000000	1"½"	Ø200	
			20000000	2"	Ø200	
	COMPLET FLOAT PN-16 Stainless steel Aisi-316	591	03000000	3/8"	Ø90	
			04000000	1/2"	Ø110	
			06000000	3/4"	Ø160	
			10000000	1"	Ø160	
			12000000	1"¼"	Ø160	
			14000000	1"½"	Ø200	
			20000000	2"	Ø200	

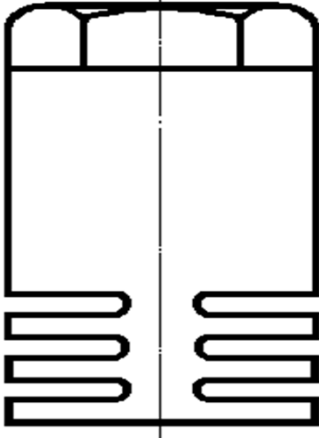
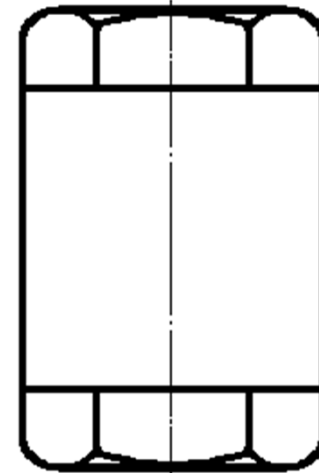
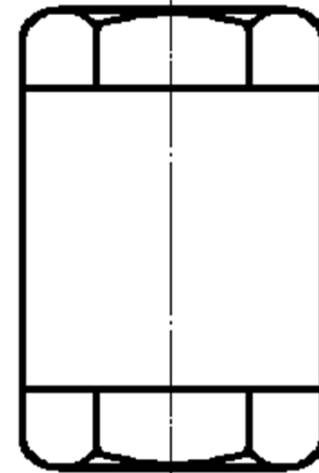
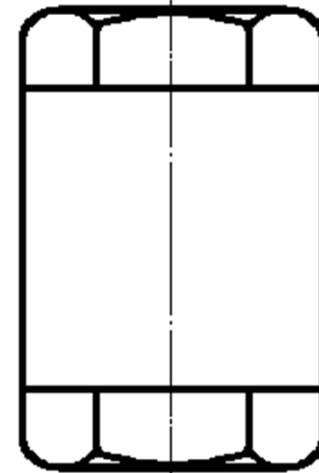
ARTICLE	DESCRIPTION	REF.	CODE	SIZE	SIZE	€
	CHECK VALVE " FOOT PUMP " METALLIC SEAL BSP female threaded Bronze / Brass	303	03000000	3/8"		
			04000000	1/2"		
			06000000	3/4"		
			10000000	1"		
			12000000	1"1/4		
			14000000	1"1/2		
			20000000	2"		
			24000000	2"1/2		
			30000000	3"		
			* 34000000	3"1/2		
40000000	4"					
	CHECK VALVE " FOOT PUMP " RUBBER SEAL BSP female threaded Bronze / Brass	303	03003000	3/8"		
			04003000	1/2"		
			06003000	3/4"		
			10003000	1"		
			12003000	1"1/4		
			14003000	1"1/2		
			20003000	2"		
			24003000	2"1/2		
			30003000	3"		
			40003000	4"		
	CHECK VALVE " INTERMEDIATE " METALLIC SEAL BSP female threaded Bronze / Brass	304	03000000	3/8"		
			04000000	1/2"		
			06000000	3/4"		
			10000000	1"		
			12000000	1"1/4		
			14000000	1"1/2		
			20000000	2"		
			24000000	2"1/2		
			30000000	3"		
			40000000	4"		
	CHECK VALVE " INTERMEDIATE " RUBBER SEAL BSP female threaded Bronze / Brass	304	03003000	3/8"		
			04003000	1/2"		
			06003000	3/4"		
			10003000	1"		
			12003000	1"1/4		
			14003000	1"1/2		
			20003000	2"		
			24003000	2"1/2		
			30003000	3"		
			40003000	4"		

VALFONTA

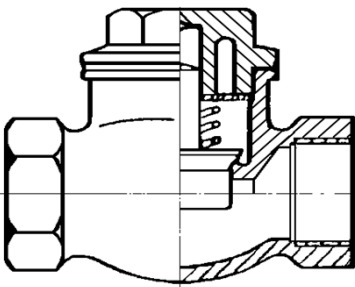
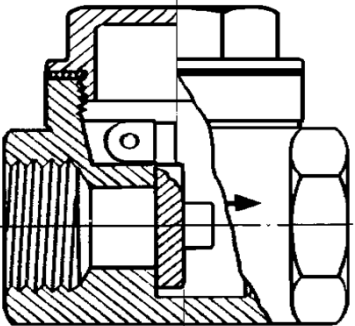
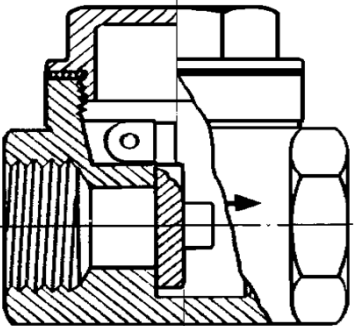
ARTICLE	DESCRIPTION	REF.	CODE	SIZE	SIZE	€
	<p>CHECK VALVE Piston system BSP female threaded BRONZE</p>	305	03000000	3/8"		
			04000000	1/2"		
			06000000	3/4"		
			10000000	1"		
			12000000	1"1/4		
			14000000	1"1/2		
			20000000	2"		
			24000000	2"1/2		
				<p>CHECK VALVE Swing system METALLIC BRASS</p>		
04000000	1/2"					
06000000	3/4"					
10000000	1"					
12000000	1"1/4					
14000000	1"1/2					
20000000	2"					
24000000	2"1/2					
30000000	3"					
40000000	4"					
	<p>CHECK VALVE Swing system RUBBER BRASS</p>	307	03003000	3/8"		
			04003000	1/2"		
			06003000	3/4"		
			10003000	1"		
			12003000	1"1/4		
			14003000	1"1/2		
			20003000	2"		
			24003000	2"1/2		
			30003000	3"		
			40004000	4"		

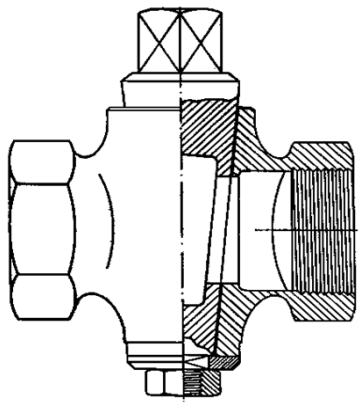
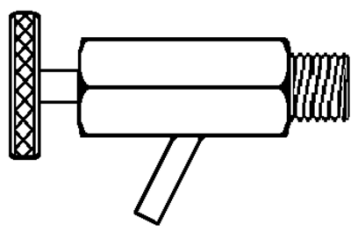
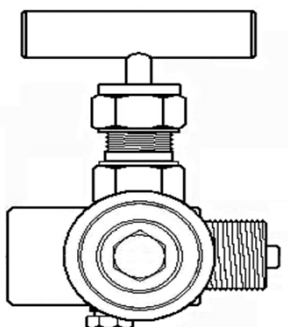
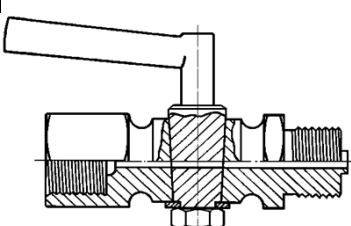
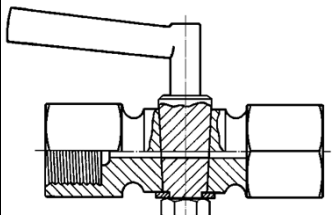
ARTICLE	DESCRIPTION	REF.	CODE	SIZE	SIZE	€
	<p>HEATING TAP female - female BRONZE / BRASS BSP THREADED PN-16</p>	219	02000000	1/4"	1/4"	
			03000000	3/8"	3/8"	
			04000000	1/2"	1/2"	
			06000000	3/4"	3/4"	
			10000000	1"	1"	
			12000000	1"1/4	1"1/4	
			14000000	1"1/2	1"1/2	
			20000000	2"	2"	
	<p>SAMPLE TAP SEAL PTFE Stainless steel Aisi-316 BSP MALE THREADED PN-10</p>	220.2	04000020	1/2"		
	<p>GAUGE TAP WITH PLATE Needle valve Stainless steel Aisi-316 BSP MALE - FEMALE THREADED Without purge PN-300</p> <p>Request for : NPT, Steel, Brass, with purge cap, wheel, . . .</p>	222.2	02000020	1/4"	1/4"	
			04000020	1/2"	1/2"	
	<p>GAUGE TAP BSP MALE - FEMALE THREADED BRONZE Male tapered tap tuned PN-25</p>	225	20000000	1/4"	1/4"	
			30000000	3/8"	3/8"	
			40000000	1/2"	1/2"	
			60000000	3/4"	3/4"	
	<p>GAUGE TAP BSP FEMALE - FEMALE THREADED BRONZE Male tapered tap tuned PN-25</p>	226	20000000	1/4"	1/4"	
			30000000	3/8"	3/8"	
			40000000	1/2"	1/2"	
			60000000	3/4"	3/4"	

VALFONTA

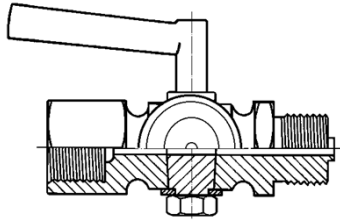
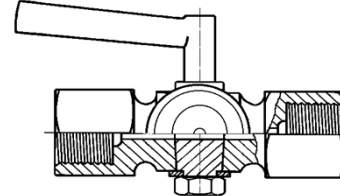
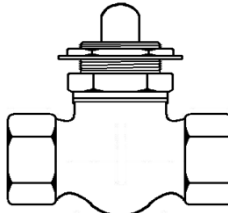
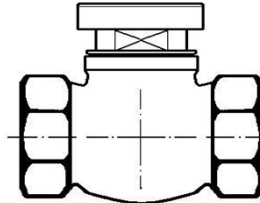
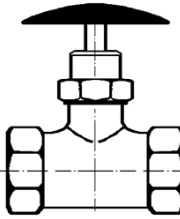
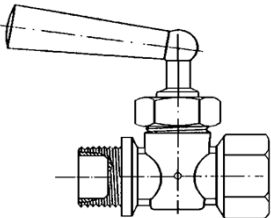
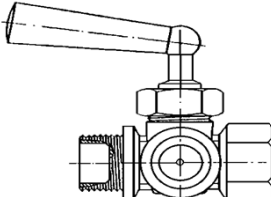
ARTICLE	DESCRIPTION	REF.	CODE	SIZE	SIZE	€
	<p>GAUGE TAP WITH PLATE BSP MALE - FEMALE THREADED BRONZE Male tapered tap tuned PN-25</p>	227	20000000 30000000 40000000 60000000	1/4" 3/8" 1/2" 3/4"	1/4" 3/8" 1/2" 3/4"	
	<p>GAUGE TAP WITH PLATE BSP FEMALE - FEMALE THREADED BRONZE Male tapered tap tuned PN-25</p>	228	20000000 30000000 40000000 60000000	1/4" 3/8" 1/2" 3/4"	1/4" 3/8" 1/2" 3/4"	
	<p>BUTTON TAP BSP FEMALE - FEMALE THREADED Chrome pivot BRASS</p>	235	40000000	1/2"	1/2"	
	<p>BUTTON TAP BSP FEMALE - FEMALE THREADED Flat chrome pivot BRASS</p>	236	06000000	3/4"	3/4"	
	<p>BUTTON TAP BSP FEMALE - FEMALE THREADED BRASS</p>	237	40000000	1/2"	1/2"	
	<p>GAUGE TAP WITH PURGE BSP MALE - FEMALE THREADED Male tapered tap tuned with estopada BRASS</p>	238	20000000 30000000 40000000	1/4" 3/8" 1/2"	1/4" 3/8" 1/2"	
	<p>GAUGE TAP WITH PLATE BSP MALE - FEMALE THREADED Male tapered tap tuned with estopada BRASS</p>	239	20000000 30000000 40000000	1/4" 3/8" 1/2"	1/4" 3/8" 1/2"	

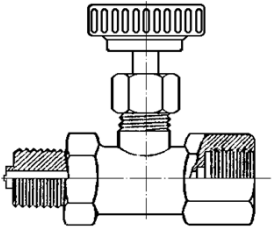
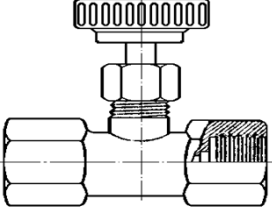
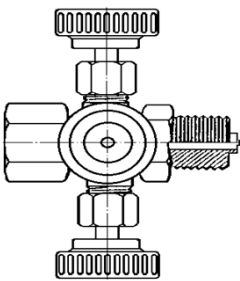
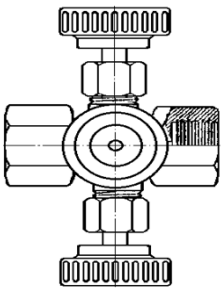
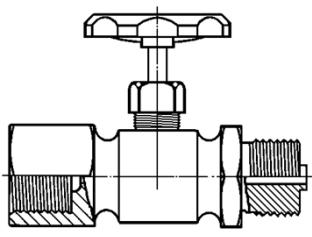
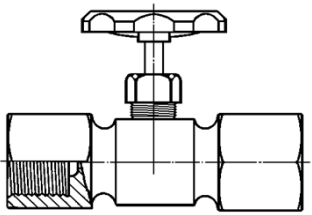
ARTICLE	DESCRIPTION	REF.	CODE	SIZE	SIZE	€
	<p>GAUGE TAP BSP MALE - FEMALE THREADED BRONZE Piston seal PN-40</p>	240	20000000	1/4"	1/4"	
			30000000	3/8"	3/8"	
			40000000	1/2"	1/2"	
			60000000	3/4"	3/4"	
	<p>GAUGE TAP BSP FEMALE - FEMALE THREADED BRONZE Piston seal PN-40</p>	241	20000000	1/4"	1/4"	
			30000000	3/8"	3/8"	
			40000000	1/2"	1/2"	
			60000000	3/4"	3/4"	
	<p>GAUGE TAP WITH PLATE BSP MALE - FEMALE THREADED BRONZE Piston seal PN-40</p>	242	20000000	1/4"	1/4"	
			30000000	3/8"	3/8"	
			40000000	1/2"	1/2"	
			60000000	3/4"	3/4"	
	<p>GAUGE TAP WITH PLATE BSP FEMALE - FEMALE THREADED BRONZE Piston seal PN-40</p>	243	20000000	1/4"	1/4"	
			30000000	3/8"	3/8"	
			40000000	1/2"	1/2"	
			60000000	3/4"	3/4"	
	<p>GAUGE TAP BSP MALE - FEMALE THREADED BRONZE Piston seal PN-64</p>	245	20000000	1/4"	1/4"	
			30000000	3/8"	3/8"	
			40000000	1/2"	1/2"	
			60000000	3/4"	3/4"	
	<p>GAUGE TAP BSP FEMALE - FEMALE THREADED BRONZE Piston seal PN-64</p>	246	20000000	1/4"	1/4"	
			30000000	3/8"	3/8"	
			40000000	1/2"	1/2"	
			60000000	3/4"	3/4"	

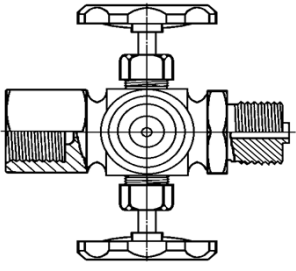
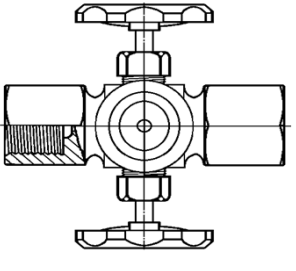
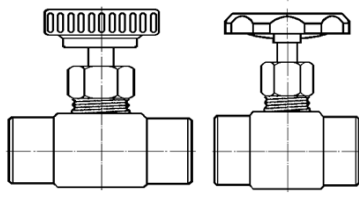
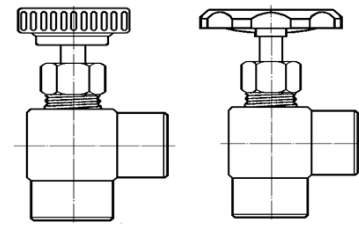
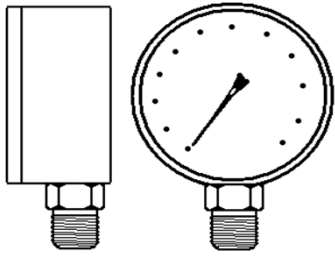
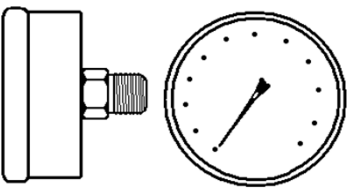
ARTICLE	DESCRIPTION	REF.	CODE	SIZE	SIZE	€
	<p>GAUGE TAP WITH PLATE BSP MALE - FEMALE THREADED</p> <p>BRONZE Piston seal PN-64</p>	247	20000000 30000000 40000000	1/4" 3/8" 1/2"	1/4" 3/8" 1/2"	
	<p>GAUGE TAP WITH PLATE BSP FEMALE - FEMALE THREADED</p> <p>BRONZE Piston seal PN-64</p>	248	20000000 30000000 40000000	1/4" 3/8" 1/2"	1/4" 3/8" 1/2"	
	<p>LINEAL SPECIAL TAP BSP FEMALE - FEMALE THREADED</p> <p>BRASS Piston seal PN-32</p>	254	10000000 20000000 30000000 40000000	1/8" 1/4" 3/8" 1/2"	1/8" 1/4" 3/8" 1/2"	
	<p>ANGULAR SPCEIAL TAP BSP FEMALE - FEMALE THREADED</p> <p>BRASS Piston seal PN-32</p>	264	10000000 20000000 30000000 40000000	1/8" 1/4" 3/8" 1/2"	1/8" 1/4" 3/8" 1/2"	
	<p>VERTICAL PRESSURE GAUGE box: AISI 304 trim: Brass Range(bar): 0-1 0-1,6 0-2,5 0-4 0-6 0-10 0-16 0-25 0-40 0-100 0-250 0-600 0-1000 Without glycerin</p>	700	02000050 02000063 04000080 04000100 04000160	Ø50 Ø63 Ø80 Ø100 Ø160	1/4" 1/4" 1/2" 1/2" 1/2"	
	<p>POSTERIOR PRESSURE GAUGE box: AISI 304 trim: Brass Range(bar): 0-1 0-1,6 0-2,5 0-4 0-6 0-10 0-16 0-25 0-40 0-100 0-250 0-600 0-1000 Without glycerin</p>	710	02000050 02000063 04000080 04000100 04000160	Ø50 Ø63 Ø80 Ø100 Ø160	1/4" 1/4" 1/2" 1/2" 1/2"	

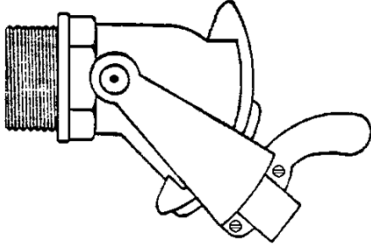
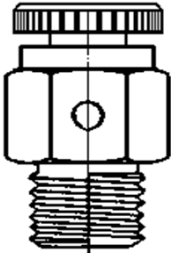
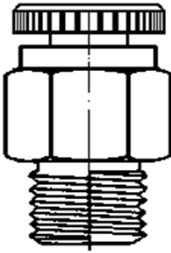
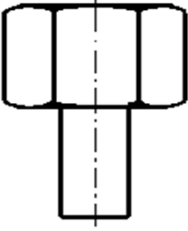
ARTICLE	DESCRIPTION	REF.	CODE	SIZE	SIZE	€
	<p>LANDFILL TAP "RAPID" BRASS / BRONZE Antigoteo Tuned seal BSP male threaded</p>	287	04000000	1/2"		
			06000000	3/4"		
			10000000	1"		
			12000000	1"1/4		
			14000000	1"1/2		
			20000000	2"		
			24000000	2"1/2		
			30000000	3"		
			40000000	4"		
	<p>SIDE PURGE TAP BRASS BSP male threaded</p>	288	10000000	1/8"		
			20000000	1/4"		
			30000000	3/8"		
			40000000	1/2"		
			60000000	3/4"		
	<p>FRONT PURGE TAP BRASS BSP male threaded</p>	289	10000000	1/8"		
			20000000	1/4"		
			30000000	3/8"		
			40000000	1/2"		
			60000000	3/4"		
	<p>DOWEL CONNECTION Welding dowel BSP female threaded BRASS</p>	292	20000000	1/4"	Ø8mm	
			30000000	3/8"	Ø11mm	
			40000000	1/2"	Ø13mm	
			60000000	3/4"	Ø15mm	